

**210-845-185**  
**COTTLE-KAZANJIAN**  
 Knochensplitterzange, zum Entfernen eines Nasenhäckers, 180 mm  
 Bone cutting forceps, for removal of nasal hump, 7 inch



**210-855-180**  
**RUSKIN-ROWLAND**  
 Nasenzange mit Doppelgelenk, gerade, 180 mm  
 Nasal hump rongeur, double action, straight, 7 inch



**420-370-210**  
**RUBIN**  
 Knorpelquetschzange mit Doppelgelenk, gerade, 220 mm  
 Septum morcelizer, double action, straight, 8 1/2 inch

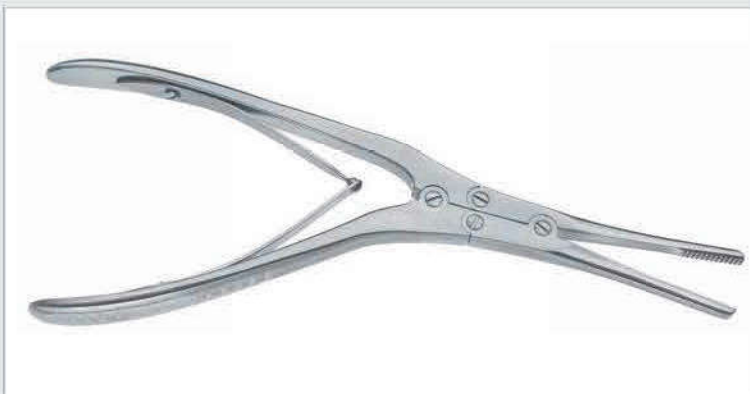

**420-371-210**  
**RUBIN**  
 Knorpelquetschzange mit Doppelgelenk, abgewinkelt, 220 mm  
 Septum morcelizer, double action, angled, 8 1/2 inch



**420-370-212**  
 Schutzkappe für RUBIN Quetschzange 420-370-210 + 420-371-210  
 Protection cap for RUBIN septum morcelizer 420-370-210 + 420-371-210



420-546-180 5 mm  
**FREER**  
 Elevatorium, scharf/stumpf, 185 mm  
 Elevator, sharp /blunt, 7 1/4 inch

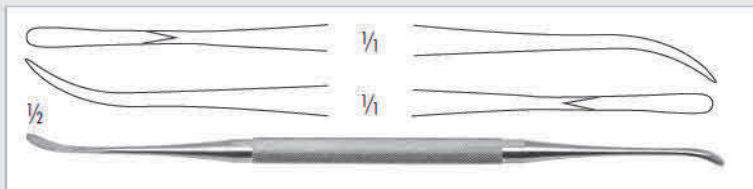

420-548-180  
**FREER-YASARGIL**  
 Dissektor, scharf, 190 mm  
 Dissector, sharp, 7 1/2 inch



210-528-240  
**COHEN**  
 Elevator, doppelendig, 240mm  
 Elevator, double-ended, 9 1/2 inch



420-556-200  
**WOODSON**  
 Elevator, 2,4 / 4,0mm Blatt, 200mm  
 Elevator, 2.4 / 4.0mm blade, 8 inch



420-395-205 6 mm  
**NEGUS**  
 Saugdissektor, stumpf 210 mm  
 Suction dissector, blunt, 8 1/4 inch



420-253-185 3 mm  
**GORNEY**  
 Saugraspatorium, halb-scharf 180 mm  
 Suction raspatory, semi-sharp 7 inch

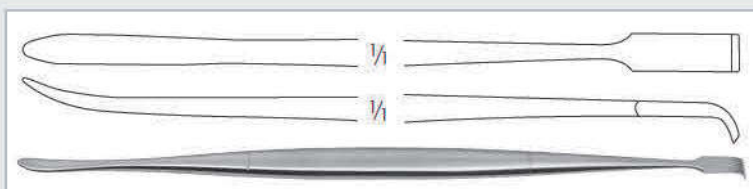

420-552-215  
**HOWARTH**  
 Doppel-Elevatorium, 215 mm  
 Elevator, double-ended, 8 1/4 inch

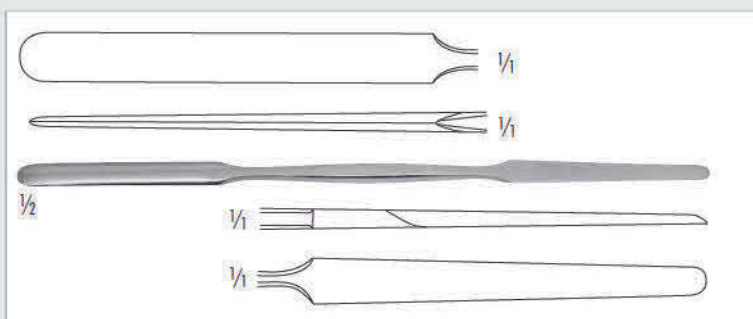

420-541-180  
**KILLIAN**  
 Doppel-Elevatorium, scharf/stumpf, 185 mm  
 Elevator, double-ended, sharp/blunt, 7 1/4 inch

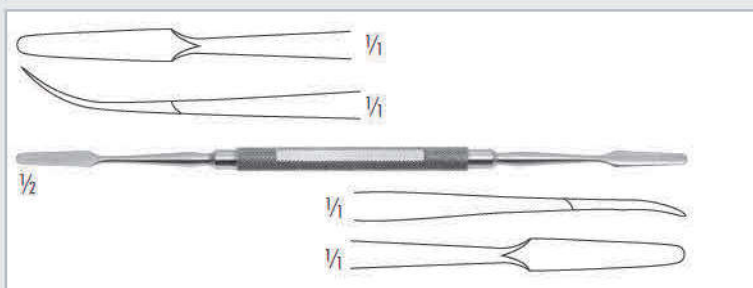

420-540-180  
**KILLIAN**  
 Doppel-Elevatorium, scharf/stumpf, 180 mm  
 Elevator, double-ended, sharp/blunt, 7 inch



252-002-180  
**KILLIAN**  
Doppel-Elevatorium, schiffenförmig, scharf/stumpf, 180 mm  
Septum double-ended elevator, shuffle-shaped, sharp/blunt, 7 inch



252-001-200  
**FREER**  
Doppel-Elevatorium, halbscharf/stumpf, 200 mm  
Septum double-ended elevator, semi-sharp/blunt, 8 inch



420-555-200  
**FREER-JOSEPH**  
Doppel-Elevatorium, 200 mm  
Septum double-ended elevator, 8 inch



420-551-200  
**MASING**  
Elevatorium, doppelendig, graduiert, scharf/stumpf, 200 mm  
Elevator, double-ended, graduated, sharp/blunt, 8 inch



420-550-230  
**COTTLE**  
Doppel-Elevatorium, graduiert, scharf/stumpf, 210 mm  
Elevator, double-ended, graduated, sharp/blunt, 8 1/4 inch

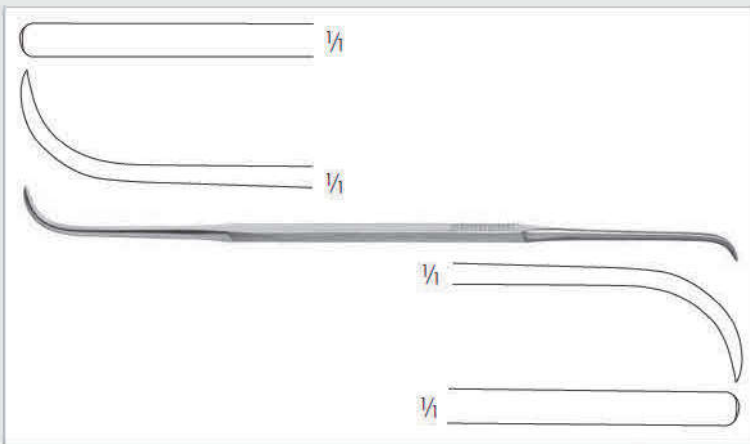

420-552-200  
**COTTLE**  
Doppel-Elevatorium, zum Tunnelieren, 220 mm  
Elevator, double-ended, for tunneling, 9 inch



420-543-210  
**PENNINGTON**  
Elevatorium, 210 mm  
Elevator, 8 1/4 inch



420-551-175  
**FREER**  
Raspatorium, doppelendig, scharf, 175 mm  
Periosteal elevator, double-ended, sharp, 7 inch



420-544-165 4,0 mm

**HALLÉ**

Elevatorium, stumpf, 180 mm

Elevator, blunt, 7 inch



420-551-180 4 mm

**FREER**

Raspatorium, 160 mm

Periosteal elevator, 6 1/2 inch



420-557-165 4,0 mm

Raspatorium, abgewinkelte Spitze, 165 mm

Periosteal elevator, angled tip, 6 1/2 inch

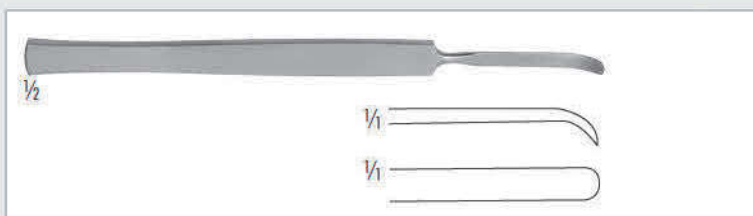

420-547-004 4 mm

420-547-005 5 mm

**MC KENTY**

Septum Elevatorium, gebogen, scharf, 155 mm

Septum periosteal elevator, curved, sharp, 6 inch



420-547-006

**ERLANGEN**

Raspatorium, 6mm breit, leicht gebogen, 175 mm

Raspatory, 6mm wide, slightly curved, 7 inch

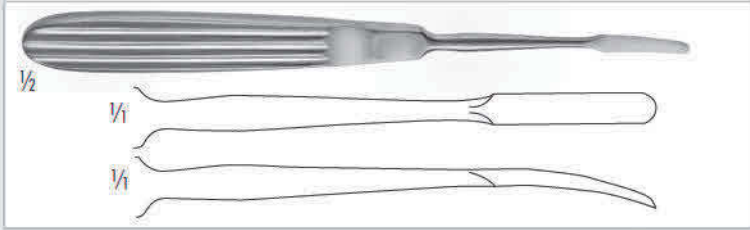

- 420-530-165 2 mm
- 420-531-165 3 mm
- 420-532-165 4 mm
- 420-533-165 5 mm

**JOSEPH**

Periost-Raspatorium, leicht gebogen, 170 mm  
 Periosteal elevator, slightly curved, 6 3/4 inch

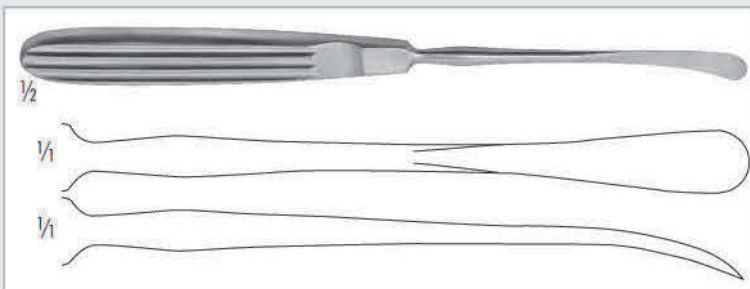

- 210-438-195 8 mm

**COTTLE**

Elevatorium, gebogen, scharf, 190 mm  
 Elevator, curved, sharp, 7 1/2 inch

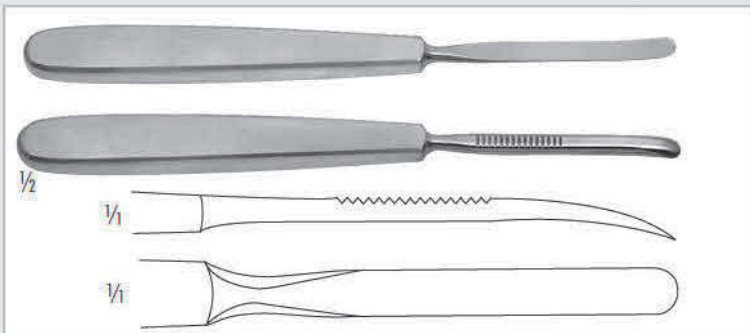

- 210-439-006 6 mm
- 210-439-008 8 mm

Periost-Raspatorium, leicht gebogen, 170 mm  
 Periosteal elevator, slightly curved, 6 3/4 inch



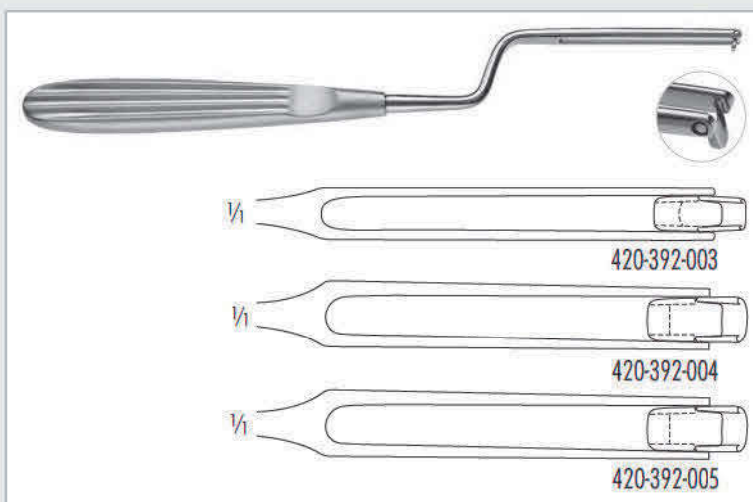

- 420-392-003 3 mm
- 420-392-004 4 mm
- 420-392-005 5 mm

**BALLENGER**

Schwingmesser, bajonettförmig, 210 mm  
Swivel knife, bayonet shaped, 8 1/4 inch

- 420-393-003 3 mm
- 420-393-004 4 mm
- 420-393-005 5 mm

**BALLENGER**

Schwingmesser, gerade, 195 mm  
Swivel knife, straight, 8 inch



- 420-590-004 4 mm, gerade/straight
- 420-591-004 4 mm, gebogen/curved

**FREER**

Septum Flachmeissel, 160 mm  
Septum chisel, 6 1/4 inch



- 420-550-170 6 mm

**FREER**

Septum-Hohlmeissel, mit runder Schneide, gerade, 150 mm  
Septum gouge, straight, round cutting edge, 6 inch

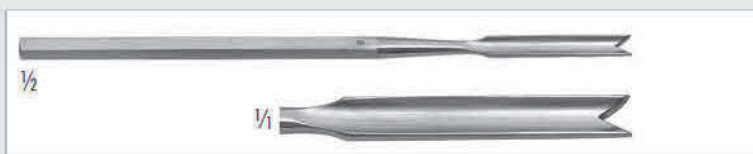

- 420-595-170 6 mm

**BALLENGER**

Septum-Hohlmeissel mit Kerbe, gerade, 155 mm  
Septum gouge, with notch and cutting edge, 6 inch



- 420-552-170 6 mm

**KILLIAN**

Septum-Hohlmeissel mit runder Schneide, bajonettförmig gebogen, 170 mm  
Septum gouge, round cutting edge, bayonet shaped, 6 3/4 inch



- 420-551-170 6 mm

**KILLIAN-CLAUS**

Septum-Hohlmeissel mit Kerbe, bajonettförmig gebogen, 170 mm  
Septum gouge with notch, bayonet shaped, 6 3/4 inch

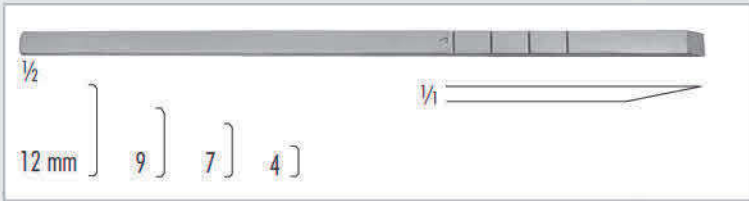

- 210-488-004 4 mm
- 210-488-007 7 mm
- 210-488-009 9 mm
- 210-488-012 12 mm

**COTTLE**

Flachmeißel, graduiert, 185 mm  
Chisel, graduated, 7 1/4 inch

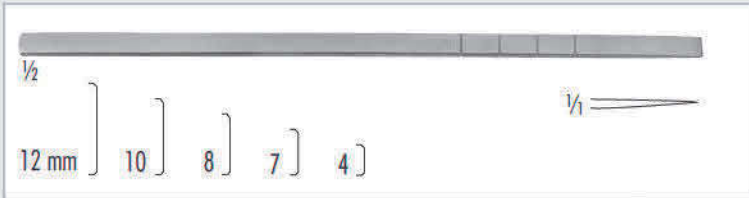

- 210-487-004 4 mm
- 210-487-007 7 mm
- 210-487-008 8 mm
- 210-487-010 10 mm
- 210-487-012 12 mm

**COTTLE**

Osteotom, graduiert, 180 mm  
Osteotome, graduated, 7 inch

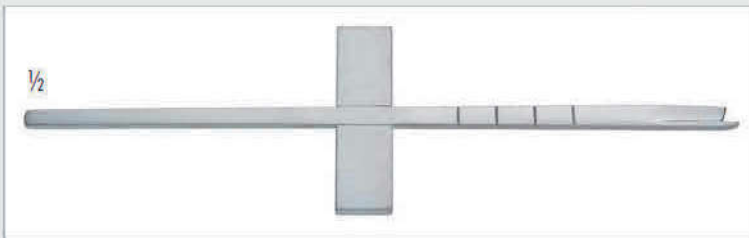

- 210-472-105 5mm

**COTTLE**

Osteotom mit Schutz und Crossbar, 185m  
Osteotome with guard and crossbar, 7 1/4 inch

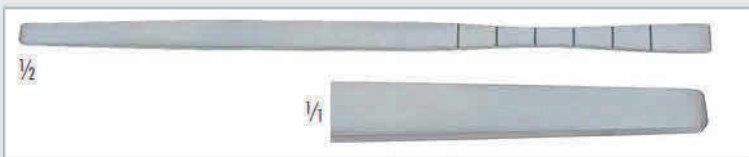

- 210-486-008 8 mm

**COTTLE**

Fischschwanz Osteotom, verrundete Ecken 180 mm  
Fishtail osteotome, with protected ends, double guarded 7 inch

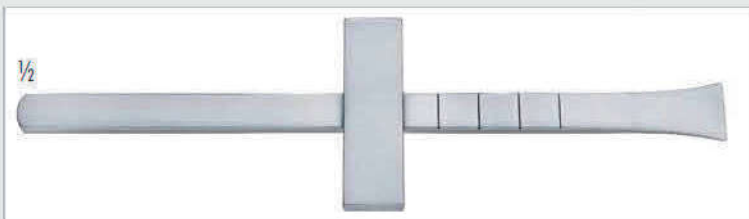

- 210-486-016

**COTTLE**

Fischschwanz Osteotom, mit Querbalken, 16mm,  
runde Schneidkanten, 180mm  
Fishtail osteotome, with crossbar, 16mm  
with round cutting end, 7 inch



- 210-486-006 6 mm

**COTTLE**

Flachmeißel, gebogen, graduiert, für transversale Osteotomie, 180 mm  
Chisel, curved, graduated, for transverse osteotomies, 7 inch

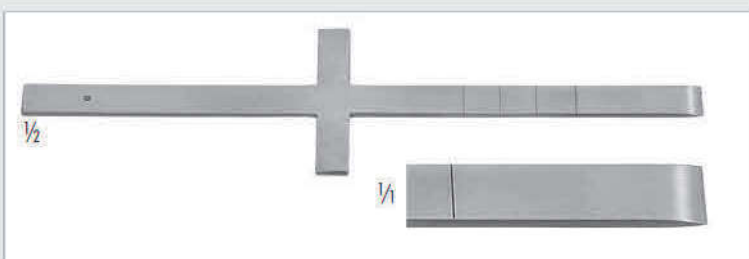

- 210-472-006 6 mm

**COTTLE**

Osteotom, gerade, 185 mm  
Osteotome, straight, 7 1/4 inch

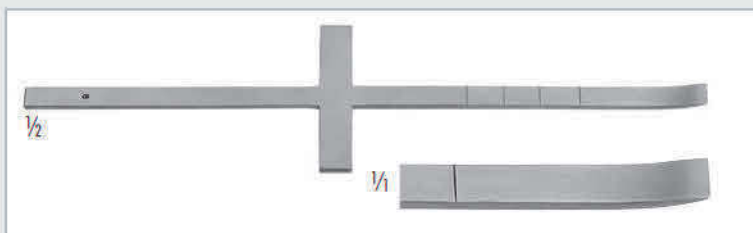

210-473-006 6 mm

**COTTLE**

Osteotom, gebogen, 185 mm  
Osteotome, curved, 7 1/4 inch

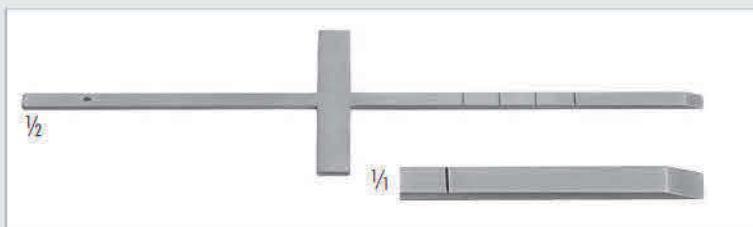

210-474-006

**COTTLE**

Meißel, gerade, 6 mm, 185 mm  
Chisel, straight, 6 mm, 7 1/4 inch



420-587-008 8 mm

420-587-010 10 mm

420-587-012 12 mm

420-587-014 14 mm

420-587-016 16 mm

**RUBIN**

Osteotom, 180 mm  
Osteotome, 7 inch



420-628-253

**GUASTELLA**

Dorsal Osteotom, 18cm  
Dorsal Osteotome, 7 inch



420-589-008 8 mm

420-589-010 10 mm

420-589-012 12 mm

420-589-014 14 mm

420-589-016 16 mm

**CINELLI**

Osteotom, mit doppelter Führung, gerade, 160 mm  
Osteotome, double guarded, straight, 6 1/4 inch



420-587-177 6,5 mm

**PARKES**

Höcker Hohlmeißel, 180 mm  
Hump gouge, 7 inch



420-459-001 gerade/straight

420-459-002 rechts gebogen/curved right

420-459-003 links gebogen/curved left

**SILVER**

Nasenmeißel, 180mm  
Nasal Chisel, 7 inch





420-460-001 gerade/straight  
 420-460-002 links/left  
 420-460-003 rechts/right  
**SILVER**  
 Osteotom, schmales Modell, 185 mm  
 Osteotome, slender model, 7 1/4 inch



420-639-001 gerade/straight  
 420-639-002 rechts gebogen/curved right  
 420-639-003 links gebogen/curved left  
**ANDERSON-NEIVERT**  
 Osteotom, 185 mm, 3,5 mm  
 Osteotome, 7 1/4 inch, 3.5 mm



420-641-001 gerade/straight  
 420-641-002 rechts/right  
 420-641-003 links/left  
**GUNTER**  
 Osteotom, 205 mm  
 Osteotome, 8 inch



420-472-002 links/left  
 420-472-003 rechts/right  
**GUASTELLA**  
 Osteotom, 180 mm  
 Osteotome, 7 inch



420-460-005  
**SILVER**  
 Osteotom mit V-Spitze, gebogen, 175 mm  
 Osteotome with V-tip, curved, 6 3/4 inch



420-491-001 links gebogen/curved left  
 420-491-002 rechts gebogen/curved right  
 420-491-000 gerade/straight  
**FRENCHAY**  
 Nasenmeißel, mit Führung, 180 mm  
 Nasal Chisel, with guard, 7 inch



420-586-004 4mm 420-586-006 6mm  
 420-586-005 5mm 420-586-007 7mm  
**FOMON**  
 Meißel, 170 mm  
 Chisel, 6 3/4 inch



420-458-160  
**PARKES**  
 Osteotom, mit einseitigem Schutz, 160 mm  
 Osteotome with single guard, 6 1/3 inch



420-470-001 gerade/straight  
 420-470-002 rechts gebogen/curved right  
 420-470-003 links gebogen/curved left  
**RISTOW**  
 Osteotom, 200 mm  
 Osteotome, 8 inch

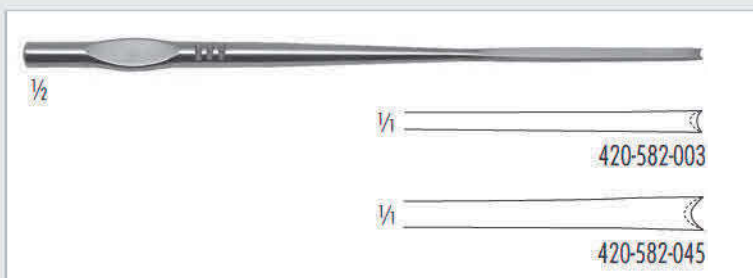

420-582-003 3,0 mm

420-582-045 4,5 mm

**WALTER**

Flachmeißel mit Hohlkehle, Spitzen verrundet, 190 mm  
Chisel with notch, double guarded, 7 1/2 inch

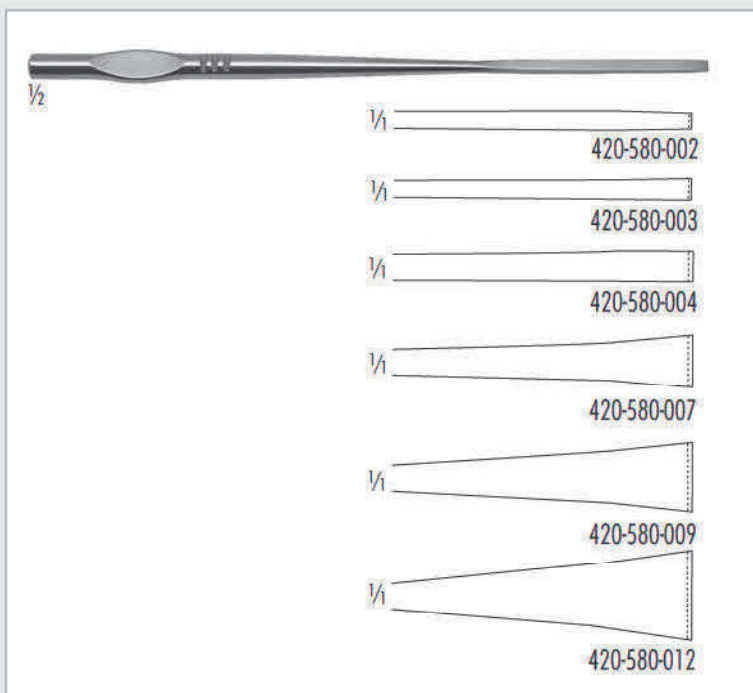

420-580-002 2,0 mm

420-580-003 3,0 mm

420-580-004 4,0 mm

420-580-007 7,0 mm

420-580-009 9,0 mm

420-580-012 12,0 mm

**WALTER**

Osteotom, 190 mm  
Osteotome, 7 1/2 inch



420-568-002 2 mm

420-568-003 3 mm

420-568-004 4 mm

420-568-005 5 mm

420-568-006 6 mm

420-568-007 7 mm

420-568-008 8 mm

420-568-009 9 mm

420-568-010 10 mm

420-568-011 11 mm

420-568-012 12 mm

420-568-014 14 mm

**RZ-OSTEOTOME**

Osteotom, 180 mm  
Osteotome, 7 inch



420-572-002 2 mm

420-572-003 3 mm

420-572-004 4 mm

420-572-005 5 mm

420-572-010 10 mm

420-572-011 11 mm

420-572-012 12 mm

**CONVERSE**

Osteotom mit Stabilisierung, 180 mm  
Osteotome with stabilizer, 7 inch



420-573-001 gerade/straight  
 420-573-002 links/left  
 420-573-003 rechts/right

**CONVERSE**

Meißel mit Schutz, 190mm  
 Chisel with single guard, 7<sup>1/2</sup>inch



420-500-200 3,0 mm

**REES**

Osteotom, mit Aluminium Handgriff, 200 mm  
 Osteotome, with aluminum handle, 8 inch



420-594-002	2 mm	420-594-007	7 mm
420-594-003	3 mm	420-594-008	8 mm
420-594-004	4 mm	420-594-010	10 mm
420-594-005	5 mm	420-594-012	12 mm
420-594-006	6 mm	420-594-015	15 mm

**SHEEHAN**

Osteotom, 175 mm  
 Osteotome, 7 inch



420-596-002	2 mm
420-596-003	3 mm
420-596-004	4 mm
420-596-006	6 mm
420-596-008	8 mm
420-596-010	10 mm
420-596-011	11 mm
420-596-015	15 mm

**TARDY**

Osteotom, 160 mm  
 Osteotome, 6<sup>1/3</sup>inch

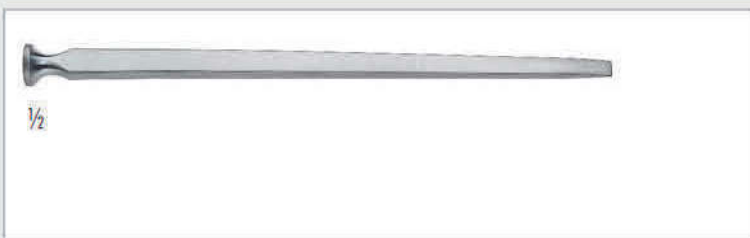

420-496-001	1 mm	420-496-007	7 mm
420-496-002	2 mm	420-496-008	8 mm
420-496-003	3 mm	420-496-009	9 mm
420-496-004	4 mm	420-496-010	10 mm
420-496-005	5 mm	420-496-012	12 mm
420-496-006	6 mm	420-496-015	15 mm

**FRENCH PATTERN**

Osteotom, 150 mm  
 Osteotome, 6 inch