

Gerade/straight		Gebogen/curved	
420-570-002	2mm	420-571-002	2mm
420-570-004	4mm	420-571-004	4mm
420-570-006	6mm	420-571-006	6mm
420-570-008	8mm	420-571-008	8mm
420-570-010	10mm	420-571-010	10mm
420-570-012	12mm	420-571-012	12mm

Mini Osteotom, 125 mm
Mini Osteotome, 5 inch



420-702-175CC	2mm
420-703-175CC	3mm
420-704-175CC	4mm
420-706-175CC	6mm

Mini Osteotom, CeraCut®, 175mm
Mini Osteotome, CeraCut®, 7 inch



Gerade/straight		Gebogen/curved	
420-502-002	2mm	420-502-102	2mm
420-502-003	3mm	420-502-103	3mm
420-502-005	5mm	420-502-105	5mm
420-502-007	7mm	420-502-107	7mm
420-502-010	10mm	420-502-110	10mm
420-502-014	14mm	420-502-114	14mm
420-502-016	16mm	420-502-116	16mm
420-502-018	18mm	420-502-118	18mm

TESSIER
Nasen Osteotom, 160 mm
Nasal Osteotome, 6^{1/3} inch



210-113-143	3mm
210-113-145	5mm
210-113-147	7mm
210-113-149	9mm

TRAUTMANN
Hohlmeissel, 140 mm
Gouge, 5^{1/2} inch



210-240-180 240 g , Ø 30 mm
COTTLE
 Hammer, 1 Seite flach, 1 Seite konvex, 190 mm
 Mallet, 1 side plain flat, 1-side convex, 7 1/2 inch



210-264-140 140 g , Ø 25 mm
 Hammer, mit auswechselbaren Kunststoffbacken
 Mallet, with interchangeable plastic disks

210-265-100
 Ersatzbackenpaar, für Hammer 210-264-140
 Pair of spare disks, for mallet 210-264-140



210-019-170 117 g , Ø 19 mm
 Hammer, mit Kupferkopf, 170 mm
 Mallet, with copper head, 6 3/4 inch



110-110-003
 Skalpell Griff Nr. 3, 130 mm
 Scalpel handle No.3, 5 1/8 inch



110-130-077
 Skalpell Griff Nr. 7, 165mm
 Scalpel handle No. 7, 6 1/2 inch



110-201-011
 Skalpellklingen Fig 11, 100 Stück
 Scalpel blades Fig. 11, 100 pieces



110-201-015
 Skalpellklingen Fig. 15, 100 Stück
 Scalpel blades Fig. 15, 100 pieces



420-213-160
BRUENINGS
 Septummesser, 160 mm
 Septum knife, 6 1/4 inch

420-213-000
 Ersatzklinge zu 420-216-160
 Spare blade for 420-216-160



420-213-140
COTTLE
 Septummesser, abgerundete Kanten, 140 mm
 Septum knife, stiff blade with rounded edge, 5 1/2 inch

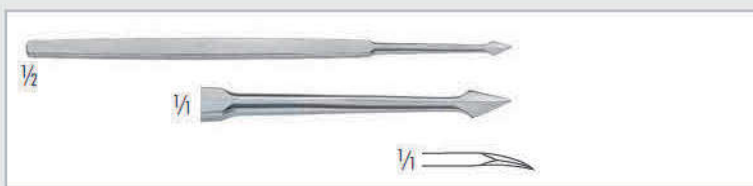

420-552-130
MASING
 Knorpelritzmesser, in der Spitze gebogen, 130 mm
 Cartilage slitting knife, curved blade, pointed, 5 1/8 inch



420-205-160
JOSEPH
 Plastikmesser, gerade, Spitze verrundet, 150 mm
 Button-end knife, straight, 6 inch



420-207-160
CONVERSE
 Plastikmesser, gebogen, Spitze verrundet, 160 mm
 Button-end knife, curved, 6 1/4 inch



420-209-175
JOSEPH
 Zugmesser zum Abtragen von Knorpelvorsprüngen des Septums, 165 mm
 Button-end knife, angled for removal of septum cartilage, 6 1/2 inch

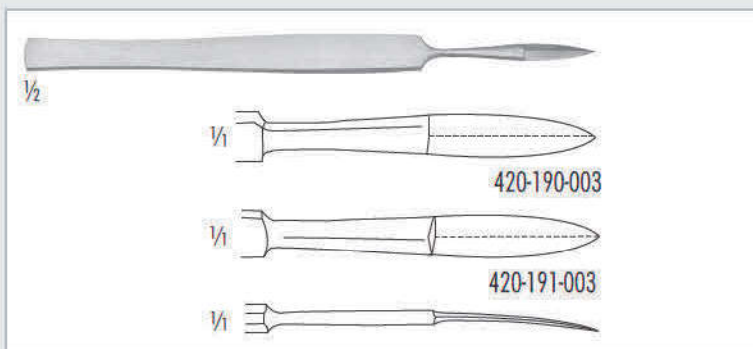

420-190-003 gerade/straight
 420-191-003 gebogen/curved
JOSEPH
 Plastikmesser mit doppelter Schneide, scharf, 160 mm
 Double-edge nasal knife, sharp, 6 1/4 inch



420-195-150
FREER
 Mukosamesser, 150 mm
 Mucosa knife, 6 inch

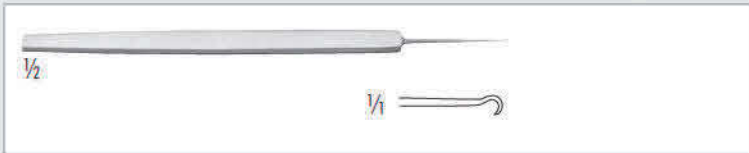

170-010-125
GRAEFE
Hauthäkchen, scharf, 120 mm
Skin hook, sharp, 4 3/4 inch

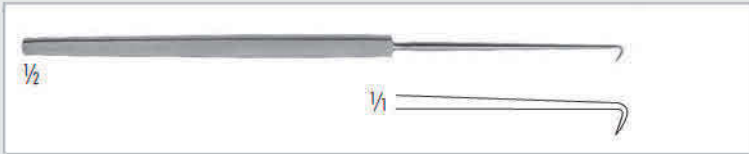

230-285-160
COTTLE
Scharfes Sehnenhäkchen, 120° retrograd gebogen, 150 mm
Tenaculum hook, 120° retrograde curved, 6 inch



230-286-160
COTTLE
Scharfes Sehnenhäkchen, 180° retrograd gebogen, 150 mm
Tenaculum hook, 180° retrograde curved, 6 inch



230-203-150
KILNER
Hauthäkchen, scharf, 150 mm
Skin hook, sharp, 6 inch



230-205-180 klein/small
230-207-180 mittel/medium
230-209-180 groß/large
GILLIES
Hauthäkchen, scharf, 180 mm
Skin hook, sharp, 7 inch



170-013-130 130 mm, 5 1/4 inch
170-013-180 180 mm, 7 inch
FRAZIER
Hauthäkchen, scharf
Skin hook, sharp



250-064-376
FISCH
Hauthäkchen, 90° abgewinkelt, scharf, 190 mm
Skin hook, 90° angled, sharp, 7 1/2 inch



170-060-001 klein/small
170-060-002 groß/large
CUSHING
Stumpfes Häkchen, 190 mm
Buttomed hook, 7 1/2 inch

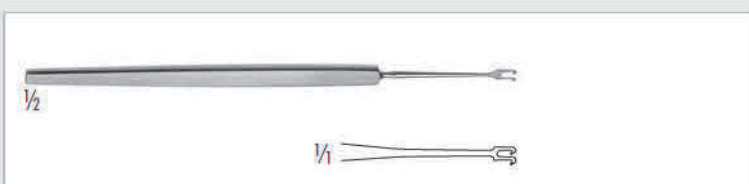

170-042-130
GUTHRIE
Hauthäkchen, Fig. 1, 120 mm
Skin hook, Fig. 1, 4 3/4 inch

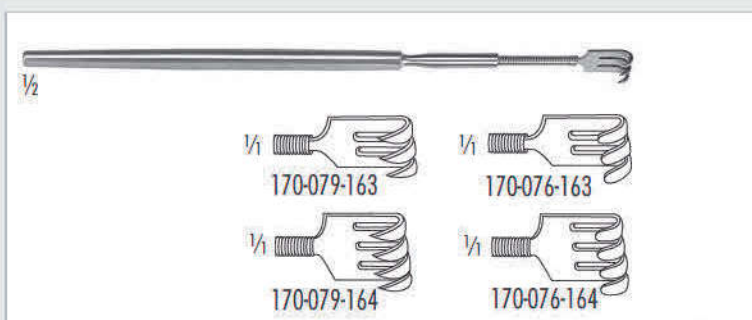
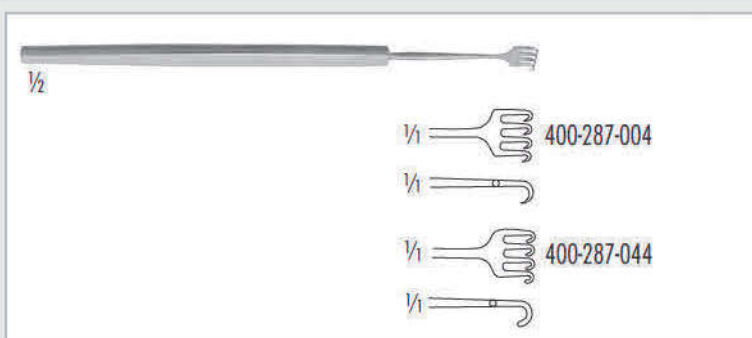
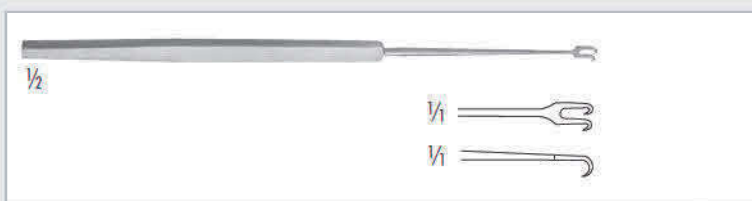
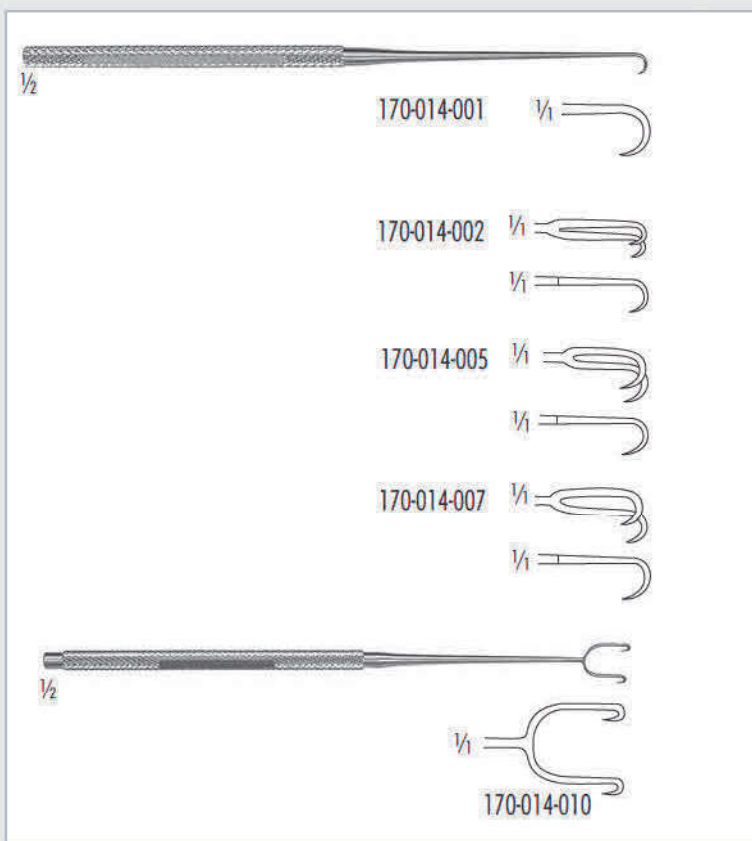

170-014-001
JOSEPH
 Hauthäkchen, scharf, 1 Zinken, 150 mm
 Skin hook, sharp, single prong, 6 inch

170-014-002 2 mm
 170-014-005 5 mm
 170-014-007 7 mm
 170-014-010 10 mm

JOSEPH
 Hauthäkchen, 2 Zinken, scharf, 160 mm
 Skin hook, sharp, 2 prongs, 6 1/4 inch

230-220-001
FREER
 Hauthäkchen, 2 Zinken, scharf, 150 mm
 Skin hook, 2 prongs, sharp, 6 inch

400-287-004 scharf/sharp
 400-287-044 stumpf/blunt
ROLLET
 Hauthäkchen, 4 Zinken, 135 mm
 Skin hook, 4 prongs, 5 1/4 inch

170-079-163 3 Zinken, scharf / 3 prongs, sharp
 170-079-164 4 Zinken, stumpf / 4 prongs, blunt
 170-076-163 3 Zinken, scharf / 3 prongs, sharp
 170-076-164 4 Zinken, stumpf / 3 prongs, blunt
 Feine Wundhaken mit flexibler Spitze, 160 mm
 Fine hand held retractor with flexible tip, 6 1/4 inch

170-008-381
COTTLE
 Wundhäkchen mit Ring, Arbeitslänge: 38 mm, scharf, 2-zahnig, 8 mm
 Thumb retractor, working length 1 1/2 inch, sharp, double hook, 8 mm wide



420-186-145
FOMON
Nasenflügelretractor, 2 Zinken, stumpf/stumpf, 140 mm
Alar retractor, 2 prongs, blunt/blunt, 5 1/2 inch

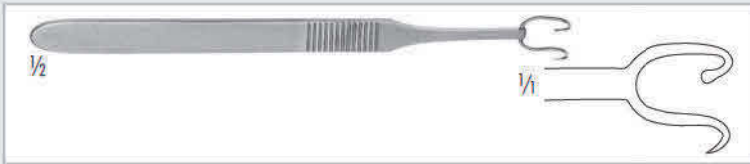

230-281-140
COTTLE
Nasenflügelretractor, 2 Zinken, stumpf/spitz, 140 mm
Alar retractor, 2 prongs, blunt/sharp, 5 1/2 inch

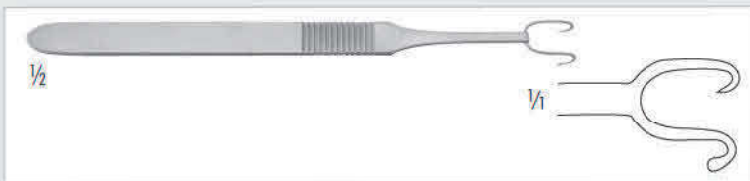

230-282-140
COTTLE
Nasenflügelretractor, 2 Zinken, spitz/stumpf, 140 mm
Alar retractor, 2 prongs, sharp/blunt, 5 1/2 inch

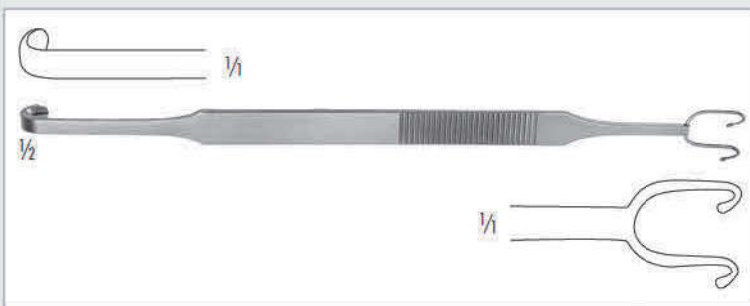

230-260-200
COTTLE-NEIVERT
Nasenflügelretractor, mit Säge- oder Messerführung,
2 Zinken, stumpf, 200 mm
Alar retractor, with saw and knife guide, 2 prongs, blunt, 8 inch

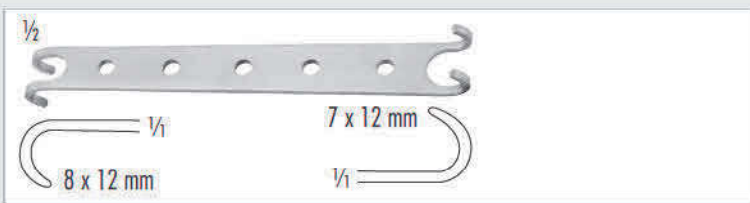

260-501-120
CONVERSE
Alar-Doppelhaken, 2 Zinken, stumpf/stumpf, 120 mm
Alar retractor, double-ended, 2 prongs, blunt/blunt, 4 3/4 inch



420-187-155 sharp
420-187-255 blunt
RUBIN
Haken, 7mm lang, 5,5mm breit
Hook, 7mm length, 5.5mm wide



420-524-150
COTTLE
Alar Retraktor mit Lippe, 150 mm
Alar retractor with lip, 6 inch



420-184-100 spitz/spitz / sharp/sharp
420-185-100 stumpf/stumpf / blunt/blunt
KILNER
Nasenflügelretractor, 2 Zinken, 85 mm
Alar retractor, 2 prongs, 3 1/4 inch

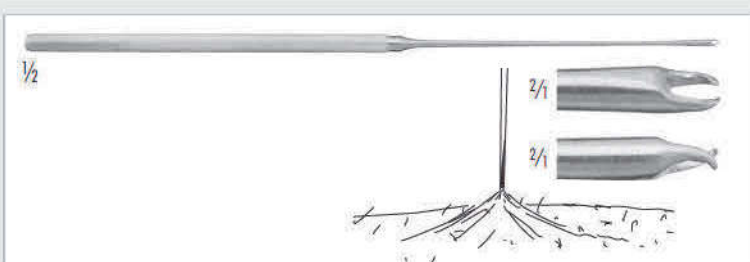

250-064-392 Ø 1,8 mm
Hautkralle mit Schutzkappe, 185 mm
Skin picks with protection cap, 7 1/4 inch

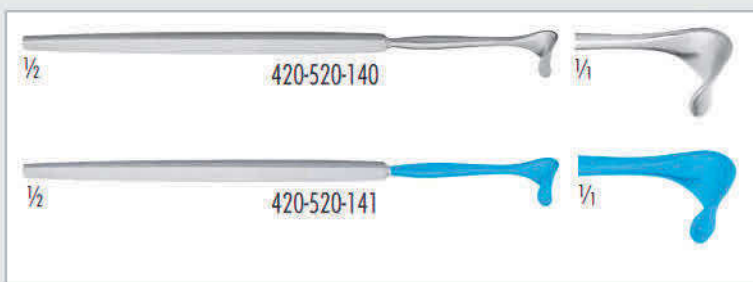

420-520-140 6x12 mm
 420-520-141 6x12 mm, **isoliert/insulated**
MASING

420-523-140 10x12 mm
 420-523-141 10x12 mm; **isoliert/insulated**
COTTLE

Alar Retraktor, 140 mm
 Alar retractor; 5 1/2 inch

420-256-135

WALTER

Doppelhaken, eine Seite mit 2 stumpfen Haken, eine Seite mit stumpfen Blatt

Double-ended retractor, one end 2 blunt prongs and one with blade



420-260-005 5mm + 42x7mm
 420-260-008 8mm + 38x7mm
 420-260-013 13mm + 38x7mm
 420-260-113 13mm + 42x10mm

AUFRICHT

Doppelendiger Nasenhaken, stumpf
 Double-ended nasal retractor, blunt



420-250-160 10x45 mm Blatt/blade
 420-251-160 10x30 mm Blatt/blade

AUFRICHT

Nasenretraktor, 160 mm
 Nasal retractor, 6 1/4 inch



420-057-160

DEVINE-MILLARD-AUFRICHT

Nasenretraktor, 10 x 45 mm Blatt, 180 mm
 Nasal retractor, 10 x 45 mm blade, 7 inch

420-257-160

Dito, mit KL-Anschluß
 Same, with fibre optic

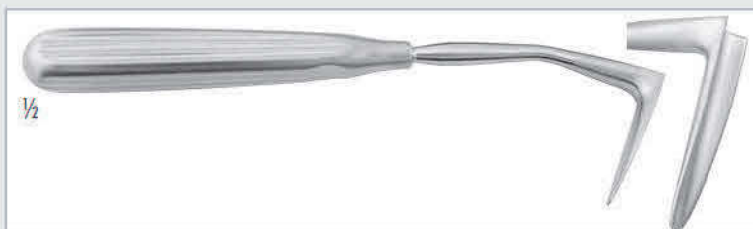

420-255-160

AUFRICHT

Nasenretraktor, mit Kaltlicht, 120°, 45 mm Blatt, 160 mm
 Nasal retractor, with fibre optic, 120°, 45 mm blade, 6 1/4 inch



420-652-100

420-752-100 mit Kaltlichtträger/with fibre optic light carrier

MALINIAC

Nasenretraktor, 9 x 45 mm, 100 mm
 Nasal retractor, 9 x 45 mm, 4 inch



420-236-110 11 x 44 mm

CONVERSE

Nasenretraktor, mit Kaltlicht, 110 mm
 Nasal retractor, with fibre optic, 4 1/3 inch





- 121-182-115 spitz/gerade / sharp/straight
- 121-183-115 spitz/gebogen / sharp/curved
- 121-184-115 stumpf/gerade / blunt/straight
- 121-185-115 stumpf/gebogen / blunt/curved

STEVENS

Super-Cut Präparierscheren, mit eckigen Ringen, 115 mm
 Super-Cut Dissecting scissors, with square rings, 4 1/2 inch

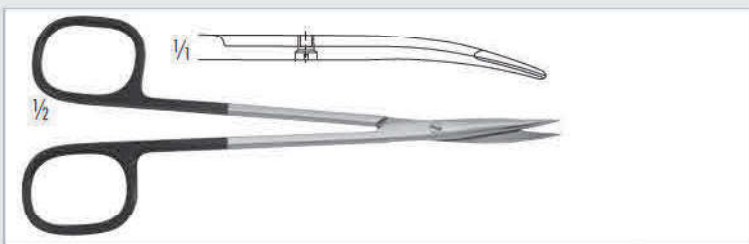

121-190-140
REYNOLDS-JAMESON

Super-Cut Gefäß-Schere, gebogen, mit eckigen Ringen, 140 mm
 Super-Cut Vessel scissors, curved, with square rings, 5 1/2 inch



- 121-187-115 gerade / straight
- 121-186-115 gebogen / curved

Super-Cut Präparierscheren, mit eckigen Ringen, 115 mm
 Super-Cut Dissecting scissors, with square rings, 4 1/2 inch

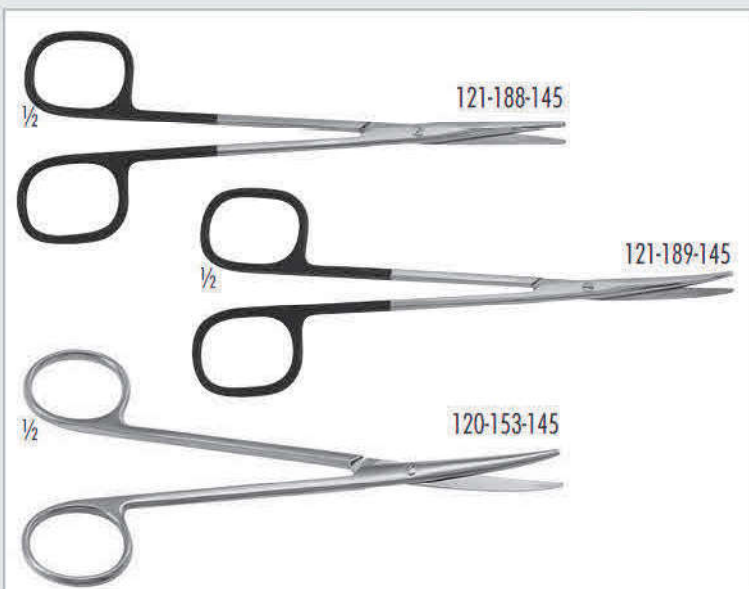

- 121-188-145 gerade / straight
- 121-189-145 gebogen / curved

METZENBAUM

Super-Cut Präparierscheren, mit eckigen Ringen, 145 mm
 Super-Cut Dissecting scissors, with square rings, 5 3/4 inch

120-153-145

METZENBAUM

Präparierscheren, feines Modell, gebogen, 145 mm
 Dissecting scissors, delicate pattern, curved, 5 3/4 inch



120-967-130 gebogen/curved

120-966-130 gerade/straight

GOLDMAN FOX

TC Sehnenschere, eine Schneide gezahnt, 130 mm

TC Tendon scissors, one blade serrated, 5 1/8 inch

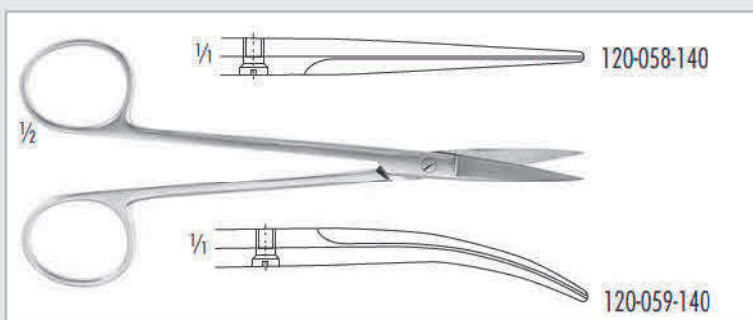

120-058-140 gerade / straight

120-059-140 gebogen / curved

JOSEPH

Plastischschere, spitz/spitz, 150 mm

Plastic scissors, sharp/sharp, 6 inch

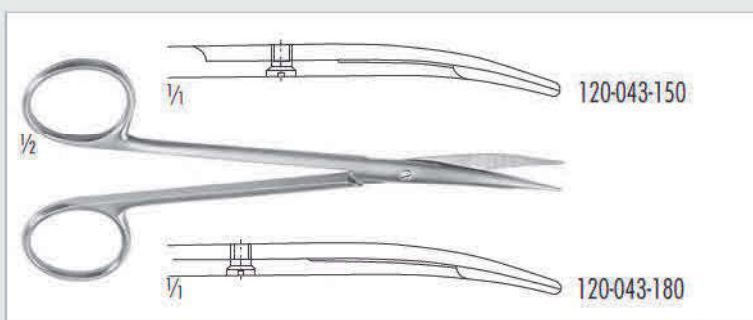

120-043-150 145 mm, 5 3/4 inch

120-043-180 175 mm, 7 inch

REYNOLDS

Präparierschere, delikate, stumpf/stumpf, gebogen

Dissecting scissors, delicate, blunt/blunt, curved

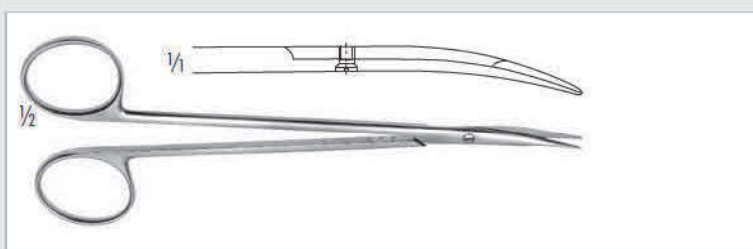

120-315-150

JAMESON

Präparierschere, delikate, stumpf/stumpf, gebogen, 150 mm

Dissecting scissors, delicate, blunt/blunt, curved, 6 inch

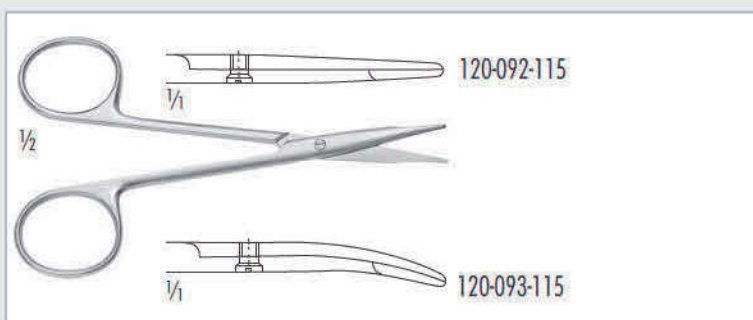

120-092-115 gerade, stumpf/stumpf

straight, blunt/blunt

120-093-115 gebogen, stumpf/stumpf

curved, blunt/blunt

STEVENS

Gefäß- und Sehnenschere, 110 mm

Vessel and tendon scissors, 4 3/8 inch

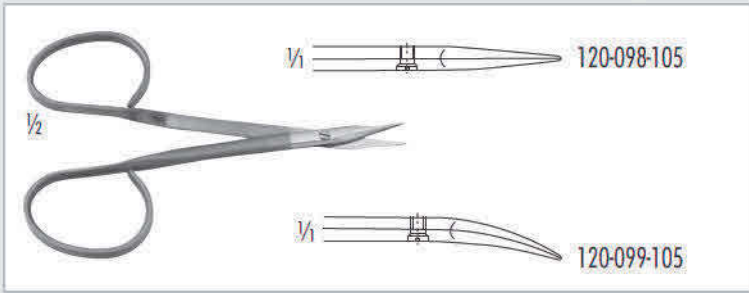

120-098-105 gerade / straight
120-099-105 gebogen / curved

STEVENS

Gefäß- und Sehnenschere, spitz, mit offenem Ring, 100 mm
Vessel and tendon scissors, sharp, with Ribbon handle, 4 inch

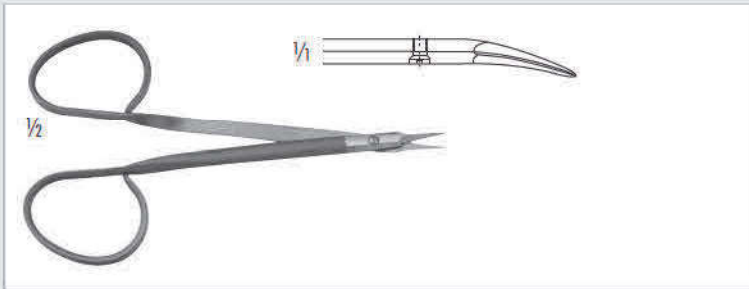

120-398-120

STEVENS

Besonders feine Präparierschere, spitz, leichtes Modell mit offenem Ring, 110 mm
Dissecting scissors, delicate, sharp, light pattern with Ribbon handle, 4 3/8 inch

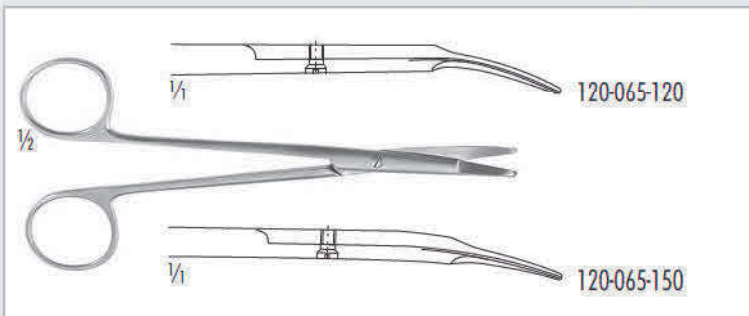

120-065-120 125 mm, 5 inch
120-065-150 150 mm, 6 inch

KILNER

Präparierschere, mit stark abgeflachten Blättern, gebogen, stumpf/stumpf
Dissecting scissors, with bevelled blade, curved, blunt/blunt

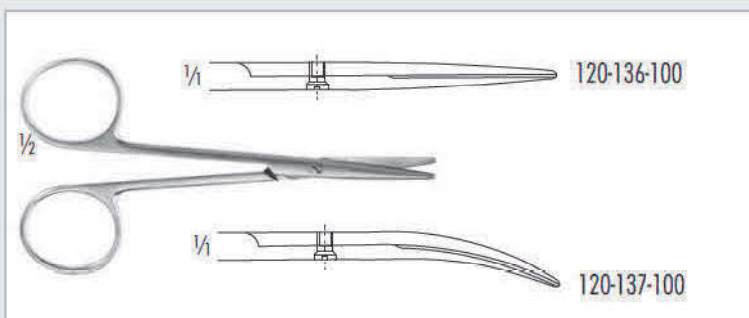

120-136-100 gerade / straight
120-137-100 gebogen / curved

COTTLE-KNAPP

Plastischschere, stumpf/stumpf, 105 mm
Plastic scissors, blunt/blunt, 4 1/8 inch

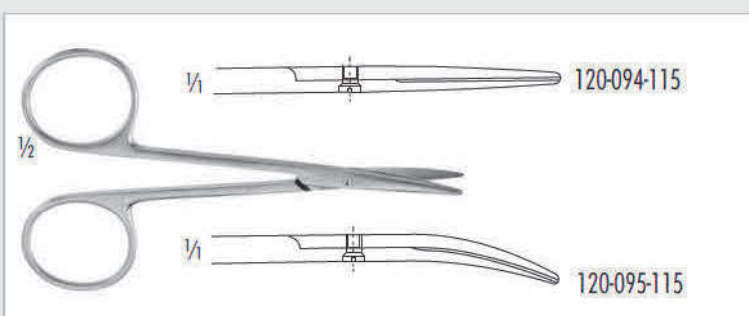

120-094-115 gerade / straight
120-095-115 gebogen / curved

STRABISMUS

Präparierschere, 115 mm
Dissecting scissors, 4 1/2 inch

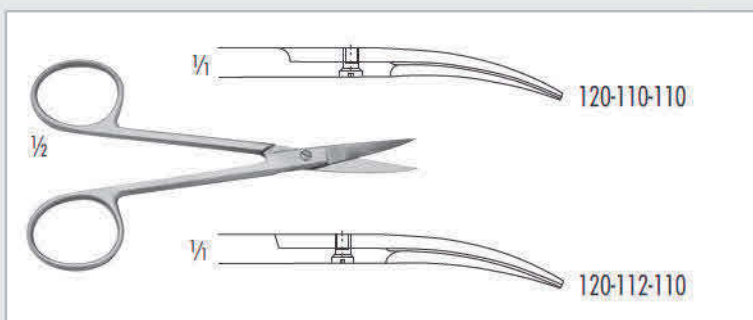

120-110-110 spitz/spitz / sharp/sharp
120-112-110 stumpf/stumpf / blunt/blunt

COTTLE-MASING

Nasenplastikschere, gebogen, 105 mm
Nasal plastic scissors, curved, 4 1/8 inch

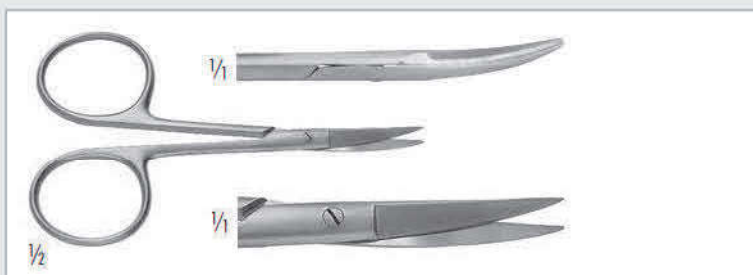

120-081-100
121-081-100 **Super Cut**

Iris Schere, gebogen, mit großen Ringen, 100 mm
Iris scissors, curved, with large handle, 4 inch

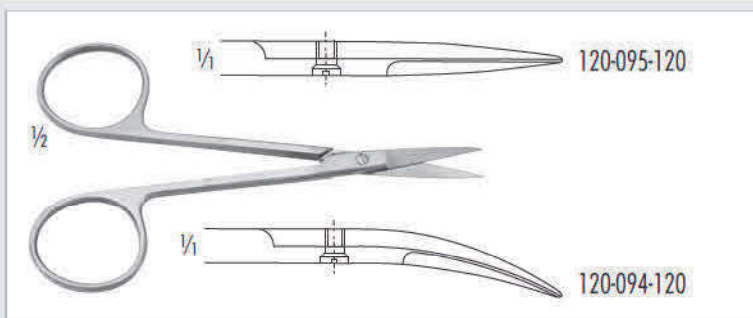

120-095-120 gerade/straight
120-094-120 gebogen/curved

Feine Schere, 115 mm
Delicate scissors, 4 1/2 inch

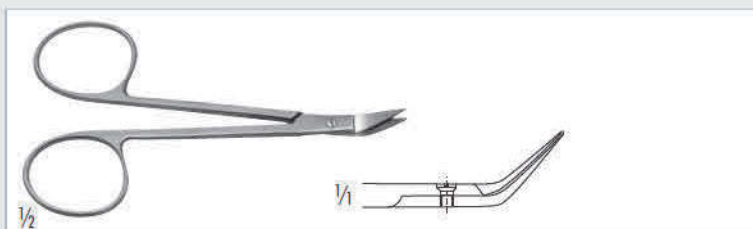

120-411-090

DANIELS

Präparierschere, 40° abgewinkelt, 90 mm
Dissecting scissors, 40° angled, 3 1/2 inch



120-411-105

BIRO

Schere, abgewinkelte Schneide, rundes Maul, 105 mm
Scissors, angled blades, round shape, 4 inch



120-511-100
121-511-100 **Super Cut**

CONVERSE

Nasenschere, aufgewinkelte Blätter, spitz/spitz, 104 mm
Nasal scissors, angled up blades, sharp/sharp, 4 1/8 inch

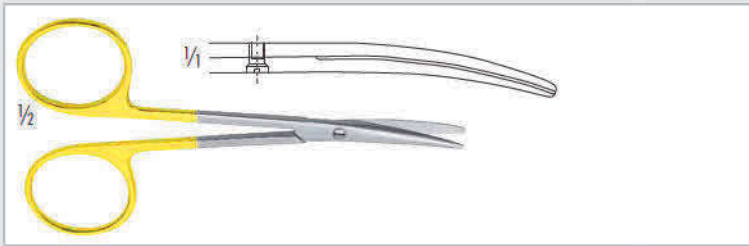

120-595-115
BABY-METZENBAUM
 TC Präparierschere, gebogen, 115 mm
 TC Dissecting scissors, curved, 4 1/2 inch



120-511-145
METZENBAUM
 TC Präparierschere, Fig 1, gebogen, 145 mm
 TC Dissecting scissors, Fig. 1, curved, 5 3/4 inch

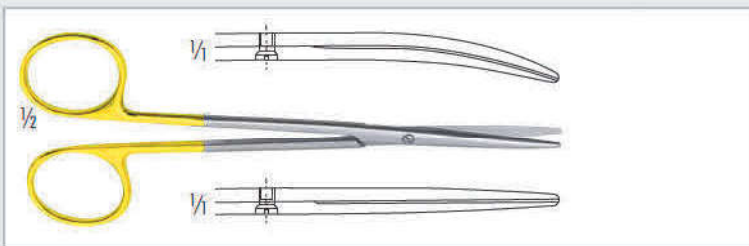

120-521-145 gebogen/curved
 120-520-145 gerade/straight
METZENBAUM-FINO
 TC Präparierschere, stumpf, 145 mm
 TC Dissecting scissors, blunt, 5 3/4 inch

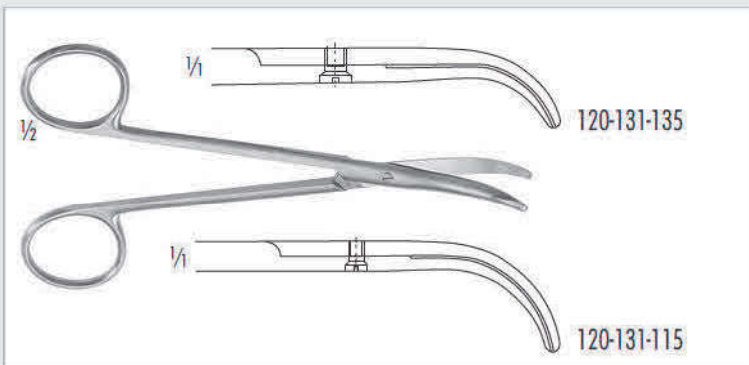

120-131-115 115 mm, 4 1/2 inch
 120-131-135 135 mm, 5 1/4 inch
FOMON
 Nasenflügelschere, stark gebogen
 Lower lateral scissors, strongly curved

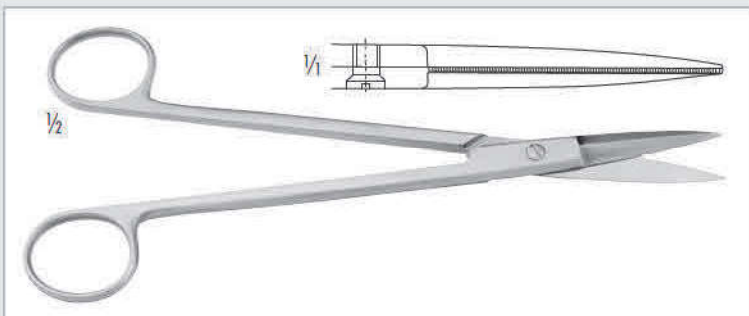

120-190-190
MC INDOE
 Knorpelschere, mit außen schneidenden Blättern,
 spitz/spitz, gerade, gezahnt, 185 mm
 Cartilage scissors, straight, serrated blades. Blades: cutting
 on both sides, sharp/sharp, 7 1/4 inch



120-281-110 stumpf, 110mm/pointed, 4 3/4 inch
 120-281-130 spitz, 130mm/pointed, 5 inch
BEUSE
 Nasenschere, leicht gebogen
 Nasal Scissors, slightly curved

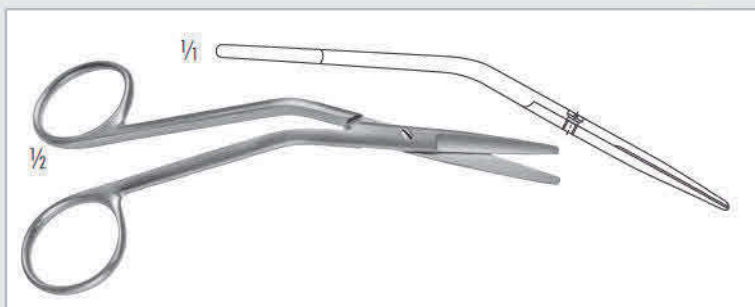

120-280-150

FOMON

Nasenschere, beide Schneiden gezahnt, kniegebogen, stumpf/stumpf, 145 mm

Dorsal scissors, straight, serrated blades, knee bent, blunt/blunt, 5 3/4 inch

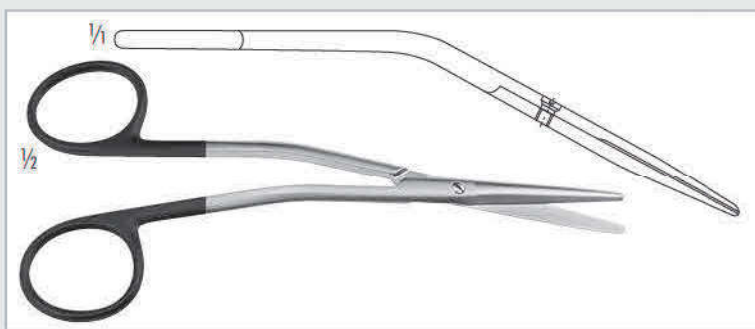

121-280-145

FOMON

SC Nasenschere, kniegebogen, ein gezahntes Blatt, 145 mm

SC Dorsal scissors, knee bent, one serrated blade, 5 3/4 inch



120-281-160

121-281-160 **Super-Cut**

120-581-160 **TC**

COTTLE

Nasenschere, kniegebogen, stumpf/stumpf, 165 mm

Dorsal scissors, straight blades, knee bent, blunt/blunt, 6 1/2 inch



120-585-180

KNIGHT

TC Nasenschere, 180 mm

TC Nasal Scissors, 7 inch



120-379-115

COTTLE

Bulldog-Schere, stumpf/stumpf, 115 mm

Bulldog scissors, blunt/blunt, 4 1/2 inch



120-053-115

CHADWICK

Schere, gebogen, spitz, 115 mm

Scissors, curved, sharp, 4 1/2 inch